

KEY FEATURES

- High power handling (300 W_{AES})
- 3" edgewound copper voice-coil with polyimide fiber glass former
- Optimum winding length for increased linear excursion
- Designed for woofer applications



GENERAL DESCRIPTION

This low frequency transducer is specially intended for the most demanding applications. Its design concept arises from the need of achieve a more resistant loudspeaker that matches the more and more power given by ultimate amplification systems. In order to accomplish that, almost every component of the speaker has been reconsidered: its voice coil has the benefits of an improved manufacturing process, made with the highest quality materials and the diaphragm has been carefully developed to give an extremely flat, smooth response. These characteristics make its integration in compact systems covering the low frequency range a straightforward task. Moreover, its parameters has been optimized to obtain an excellent bass response when used in small bass-reflex cabinets.

FREQUENCY RESPONSE AND DISTORTION CURVES

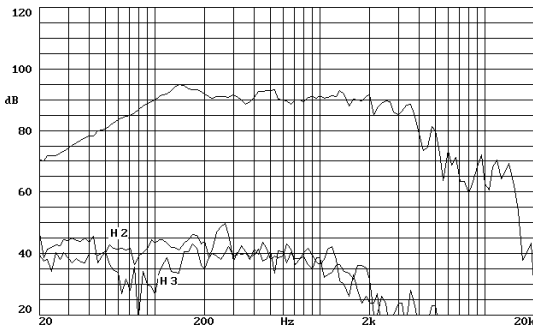

Note: on axis frequency response measured with loudspeaker standing on infinite baffle in anechoic chamber, 1w @ 1m.

FREE AIR IMPEDANCE CURVE

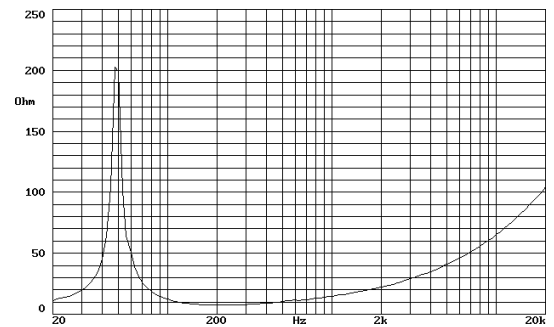

PREDICTED LOW FREQUENCY RESPONSE

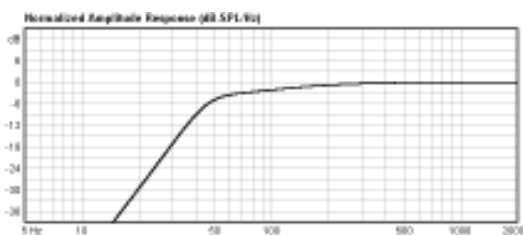

Note: Bass-reflex cabinet, Vb=30 l, fb=45 Hz

POWER COMPRESSION LOSSES

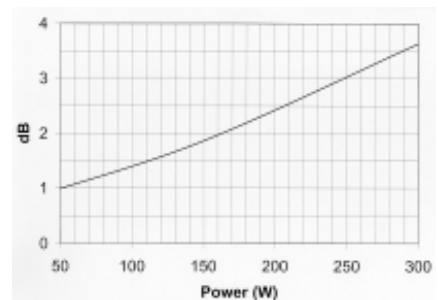

Note: These losses are calculated from a five minutes AES power test applying band limited pink noise (25-1200 Hz). The loudspeaker is free-air standing.

TECHNICAL SPECIFICATIONS

Nominal diameter	250 mm. 10 in.
Rated impedance	8 ohms
Minimum impedance	7.2 ohms
Power capacity	300 w AES
Program power	600 w
Sensitivity	96 dB 2.83v @ 1m @ 2 π
Frequency range	45 - 4000 Hz
Recom. enclosure vol.	20 / 70 l 0.7 / 2.6 ft. ³
Voice coil diameter	77 mm. 3 in.
Magnetic assembly weight	5 kg. 11 lb.
BL factor	17.9 N / A
Moving mass	0.051 kg.
Voice coil length	20 mm
Air gap height	8 mm
X damage (peak to peak)	28 mm

MOUNTING INFORMATION

Overall diameter	260.5 mm. 10.26 in.
Bolt circle diameter	243.5 mm. 9.59 in.
Baffle cutout diameter:	
- Front mount	228 mm. 8.98 in.
- Rear mount	230 mm. 9 in.
Depth	133 mm. 5.24 in.
Volume displaced by driver	3 l 0.1 ft. ³
Net weight	5.7 kg. 12.5 lb.
Shipping weight	6 kg. 13.2 lb.

THIELE-SMALL PARAMETERS

Resonant frequency, fs	55 Hz
D.C. Voice coil resistance, Re	6 ohms.
Mechanical Quality Factor, Qms	6.47
Electrical Quality Factor, Qes	0.33
Total Quality Factor, Qts	0.31
Equivalent Air Volume to Cms, Vas	33 l
Mechanical Compliance, Cms	164 μ m / N
Mechanical Resistance, Rms	2.75 kg / s
Efficiency, η (%)	1.6
Effective Surface Area, Sd (m ²)	0.0380 m ²
Maximum Displacement, Xmax	6 mm
Displacement Volume, Vd	227 cm ³
Voice Coil Inductance, Le @ 1 kHz	1 mH

DIMENSION DRAWINGS

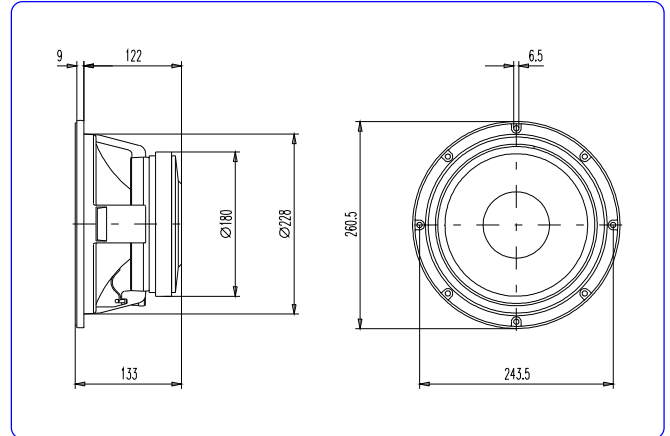

MATERIALS

- **Voice coil:** edgewound copper wire with high temperature bonding strength. Polyimide fiber glass former able to withstand high temperatures.
- **Cone:** paper cone capable to endure the most extreme conditions.
- **Surround:** treated cloth to assure good retaining of elasticity in despite of continuing use.
- **Spider:** treated cotton fibres.
- **Metal parts:** anti-corrosion coated back plate designed to resist aggressive environmental conditions.
- **Basket:** specially designed die cast aluminium basket to avoid disturbing resonances.
- **Magnet:** high Curie temperature ferrite.

Notes:

*The power capacity is determined according to AES2-1984 (r2003) standard. Program power is defined as the transducer's ability to handle normal music program material.

**T-S parameters are measured after an exercise period using a preconditioning power test. The measurements are carried out with a velocity-current laser transducer and will reflect the long term parameters (once the loudspeaker has been working for a short period of time).



acústica beyma, s.a.